

BATTLE'S OVER



A NATION'S TRIBUTE

11TH NOVEMBER 2018

100 YEARS OF REMEMBRANCE

WW1 Beacons of Light 11th November 2018

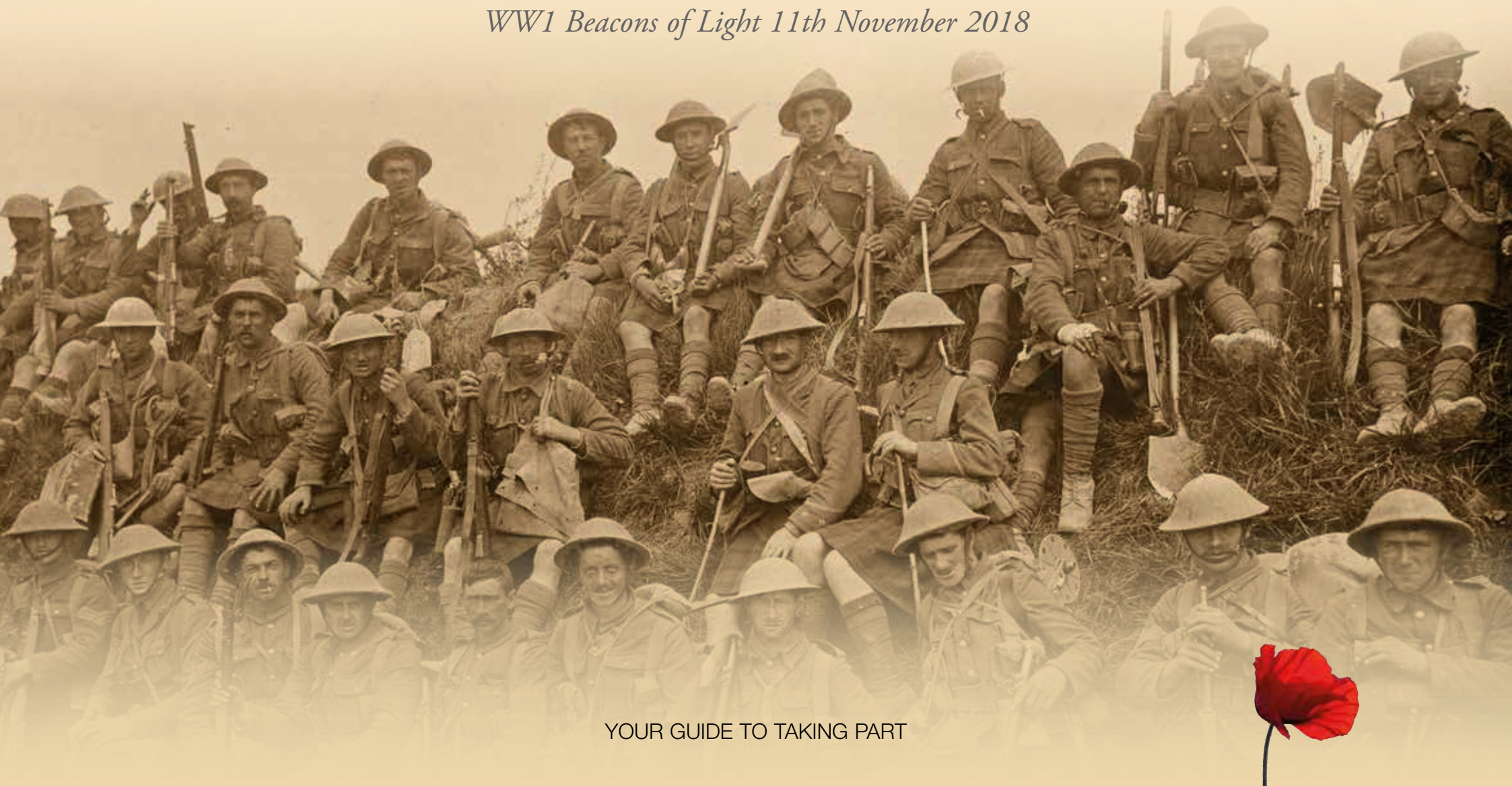

YOUR GUIDE TO TAKING PART

Introduction

BATTLE'S OVER

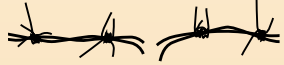

A NATION'S TRIBUTE

11TH NOVEMBER 2018

100 YEARS OF REMEMBRANCE

*Your chance to pay your
personal and community
tribute to those millions
that gave their lives
for their country
during the dreadful darkness
of four years of War
1914 - 1918*

On 3rd August 1914, Britain's Foreign Minister, Sir Edward Grey, was looking out of his office window. It was dusk, and the gas lights were being lit along London's Mall, leading to Buckingham Palace, when he remarked to a friend, "The lamps are going out all over Europe; we shall not see them lit again in our lifetime." Our country was about to be plunged into the darkness of the First World War, and it would be four long years before Britain and Europe would again experience the light of peace.

In commemoration and remembrance of the end of the war and the many millions who were killed or came home dreadfully wounded, 1000 Beacons of Light will be lit at 7pm on 11th November 2018 throughout the United Kingdom, Channel Islands, Isle of Man and UK Overseas Territories - a century after the guns fell silent. The event will also commemorate the huge army of men and women on the home front who, often in dangerous and exhausting conditions, underpinned the war effort - keeping the wheels of industry turning, bringing the harvests home to ensure the nation did not starve.

The Beacons will symbolise the 'light of hope' that emerged from the darkness of war. You will be pleased to know that to date more than 800 councils, communities and other organisations have already confirmed their involvement by lighting WWI Beacons of Light that evening. (Please see acknowledgements on pages 12-17. These pages will be updated every three months up to 31st October 2018).

For example, beacons are being lit at the Tan Hill Inn, Yorkshire Dales, the highest pub in Great Britain; on the island of Unst, the most northerly inhabited island in Scotland; St Davids, the most westerly City in Wales; Lowestoft, Suffolk, the most easterly town in England, and at St Macartin's Cathedral, Enniskillen, the most westerly location in the United Kingdom. We do hope that your council and community will link with the other 800 (to date) and take part in this unique, historic tribute.

There are a number of cost-effective ways of participating in this event.

(1) Use existing Beacon Braziers set on tall wooden poles and gas fuelled beacons previously purchased for other historic anniversaries, celebrations and commemorations.

Build and light a traditional Bonfire Beacon.

(3) You may wish to purchase the special gas-fuelled beacon being produced for this project as, once used, it can be stored away for the future and then used for other such beacon occasions making it more economic - please see page 4.

(4) Build and erect a new Beacon Brazier on a tall wooden pole, using it as a permanent tribute to those that lost their lives in your local community during World War I - see page 5. (You may need to apply for planning permission so please contact your Local Authority Planning Department seeking their advice).

Those councils and organisations taking part will be able to download a special certificate after the event as a permanent reminder of their involvement in this tribute. (Details of where to obtain it will be sent in the latter part of November 2018).

Please see page 3 for how to participate.

As you will see from pages 8, 9, 10 and 11 we have four very worthy and appropriate charities associated with this event, representing The Royal Navy, Royal Air Force, Army and Merchant Navy, so please feel free to make charitable donations direct to one or more of them. (You may also wish to consider staging a public collection for them around the lighting of your Beacon on 11th November 2018).

I look forward to hearing from you in due course.

Bruno Peek

Bruno Peek LVO OBE OPR
Pageantmaster
Battle's Over - A Nation's Tribute
& WWI Beacons of Light



How to take part & Beacon Lighting Ceremony

How to take part

Step 1: To confirm your involvement and assist us in easy communication and correct registration of your event, please be kind enough to undertake the following in FULL as soon as possible, sending it to Bruno Peek LVO OBE OPR, Pageantmaster, Battle's Over - A Nation's Tribute & WW1 Beacons of Light at - brunopeek@mac.com

If your event is a private occasion and NOT open to the public, and you do not want your involvement shown on any public or media listing, it is important that you confirm this when providing information requested below. Your participation will still be noted as part of this historic occasion but NOT made public.

However, if your event is open to the public your contact details will be shared with the media so that they can contact you direct to arrange any publicity and/or coverage of your event on 11th November 2018.

Name of Contact/Coordinator
Name of Council or Organisation
Job title of Coordinator
Full postal address including postcode
County
Country: England, Wales, Scotland, Northern Ireland, Channel Islands, Isle of Man, UK Overseas Territory
Telephone number - landline
Mobile number
Email Address
Beacon Location if known when registering, including postcode

Please ensure you have undertaken all the safety aspects etc, outlined on page 6 and before the lighting of your Bonfire Beacon on page 5 and you have alerted the emergency services, including the Fire Brigade, undertaken any risk assessments required and ensure all are happy with your plans. (This is your responsibility as coordinator of your Beacon lighting event).

Beacon Lighting Ceremony - 7pm on 11th November 2018

The Beacon lighting ceremony should be undertaken as follows:

Step 2: Invite your Lord Lieutenant, DL, Lord Mayor, Mayor, High Sheriff, High Steward, Lord Provost, Chairman or Leader of the Council. However, you may wish to consider running a competition in partnership with your local media, with the winner having the honour of lighting your WWI Beacon of Light at 7pm that evening.

Step 3: Please arrange to have professional photographs taken during your event, and immediately after, please send NO more than TWO high quality, copyright-free photographs to brunopeek@mac.com including the name of the photographer, the Beacon location, including postcode, along with the name of the Council or Organisation.

Step 4: If appropriate, please use social media channels - Twitter, Facebook etc - to promote your event. On Facebook, post photographs of your Beacon lighting ceremony on the 11th November 2018.

Step 5: On 1st November 2018 we will be providing you with an outline Press Release for your use, so please localise it, providing as much or as little information as you wish regarding your event, along with your contact details before YOU send it to all areas of your local media to enable them to contact YOU direct.

Step 6: Before the lighting of your Beacon at 7pm you may wish to consider reading out the names of those from your City, Town or Parish etc killed in action, during WWI, in remembrance of the sacrifices made.



Bonfire Beacon, Killyleagh, County Down, Northern Ireland.



Beacon at Manor Farm, Strete, Devon, courtesy of Kate Gill, Stete Parish Council.



WWI Beacons of Light, your unique gas-fuelled Beacon

The Battle's Over Beacon is of lightweight construction and comes assembled and complete with the exception of the gas cylinders that will need to be purchased separately:

a) 400g disposable cylinder of propane, (Bullfinch No 1644, or equivalent) for the FirePower Torch used to light the Beacon. These can be purchased from many DIY stores or Builders Merchants.

b) One full 47 kg propane cylinder or 2 x 19 kg full cylinders are recommended to give a full flame for an hour. For longer periods of burning or with partially full cylinders you will need double the number of cylinders. These cylinders can be purchased from Flogas Britain Ltd by calling 0800 085 6225 quoting Gas Fuelled Beacons or by going to their website www.flogas.co.uk where you can either order your cylinder online or locate your nearest Flogas stockist. You may also



download a propane cylinder safety data sheet from the Flogas website (www.flogas.co.uk/safety).

The Gas-Fuelled Beacon package will contain the following:

- Burner unit with distinct design to commemorate the event - with the motif WWI 1914 18 round the circumference
- 2m high stand with an anchor for fixing to the ground
- 10m hose with the regulator for connecting to the gas cylinders
- FirePower Gas torch for lighting the burner (you will need a 400g disposable cylinder of propane for this - (see above))
- Spanner
- Leak detecting fluid
- Hose assembly and Y manifold to link 2 cylinders
- Lighting and safety instructions

The above items are packed into 2 strong cartons.

The tripod describes a circle area of about 1.32m diameter and the beacon has an extended height of about 2.15m.



The Beacon (and flame) are stable in the wind up to 30 mph. It is supplied with a ground anchor and rope for securing to the ground if this is possible, or else we would recommend the use of sand bags. Full instructions are provided for this. The Beacon must be supervised by 2 people at all times when lit and a fire extinguisher must be provided. It is important that the supervision should be undertaken by those who are competent and it is essential that a trial be undertaken before the event to ensure that everyone is fully trained and familiar with the operation.

See our website bullfinch-gas.co.uk for more details.

The price is £360 plus VAT including carriage within the UK Mainland. There will be an extra carriage charge for other areas.

To order please contact:

Bullfinch Gas Equipment, Kings Road, Tyseley, Birmingham, B11 2AJ.



Tel: 0121 765 2000

Fax: 0121 707 0995

Email: sales@bullfinch-gas.co.uk

Web: www.bullfinch-gas.co.uk

Payment by Bank Transfer, Credit/Debit Card or Cheque. Payment will not be asked for until the Beacon is about to be despatched. Last date to order to guarantee delivery by 1st November is 31st August 2018. However please enquire after this date for availability.



Gas fuelled Beacon, Berkley Castle, Gloucestershire, England.



WWI Beacons of Light, Beacon Brazier

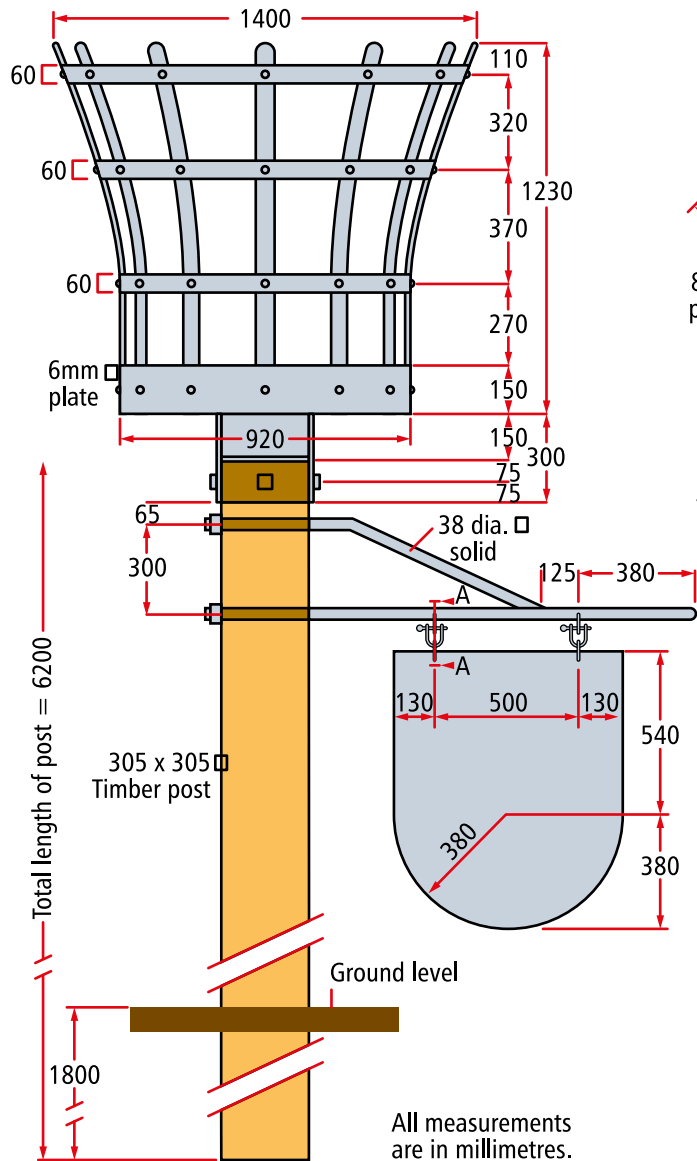

Beacon Brazier with Metal Shield

A Beacon Brazier can be a more permanent fixture, sited in a country park, hilltop or village green, as a lasting memorial of this important moment in history commemorated, and could be manufactured and erected by using local craftsmen.



Materials Required for Beacon Construction

Wooden centre post consisting of 305mm x 305mm wooden post, 6.25 metres in length of which 2 metres goes into the ground.

Basket and fixing brackets consisting of:

- 1 x 920mm diameter steel plate.
- 1 x 4,178 long 60mm x 5mm steel flat bar rolled into 1,330mm diameter ring.
- 1 x 3,455mm long 60mm x 5mm steel flat bar rolled into 1,100mm diameter ring.
- 1 x 2,985mm long 60mm x 5mm steel flat bar rolled into 950mm diameter ring.
- 1 x 2,922mm long 150mm x 5mm steel flat bar rolled into 930mm diameter ring.
- 12 x (approx 1,250mm long) 60mm x 5mm vertical bars (rolled to shape).
- 1 x 310mm x 310mm x 300mm high connection box welded to base of basket.
- 1 x hanging shield and support: 3.7m length of 38mm diameter solid steel rod.
- 1 x 920mm x 760mm steel plate 3mm thick 4 x connection brackets 8mm thick (see detailed drawings left).
- 2 x pins and loops.



WWI Beacons of Light Bonfire Beacon

Locate the bonfire at least 30m away from buildings, roads, railways and public rights of way, and a safe distance from dangerous materials and overhead power lines. Ensure it has good access for the transportation of materials for the bonfire and sufficient space for spectators to stand upwind.

Obtain the landowner's permission and involvement.

Liaise with local fire brigade and emergency services, presenting them with your plans, and seek their advice and support.

1 Prepare site by removing top layer of turf and stack away from fire area. Obtain seven poles, 5-6m in length. Attach four guy ropes to top of one pole and anchor as shown.

2 Erect remaining poles as shown, ensuring tops are secured in place.

3 Use either pallets or suitable lengths of timber, spreading them over ground area of beacon for a good through draught. Secure timber horizontally between poles as shown, preventing material placed over the framework from dropping through. Construct access

tunnel to the middle of the beacon. Keep middle empty until required. Always construct the bonfire so it collapses inwards as it burns.

4 Use only wood for combustible materials. Do not burn dangerous items such as foam-filled furniture, old tyres, aerosols or tins of paint. Build upwards until height of centre pole is reached. Materials around top should be loosely packed to allow air flow. Cover bonfire to keep it dry.

5 Fill centre with suitable, dry combustible materials. Check construction is stable and remove any unsuitable materials that may have been added. Look specifically for fireworks, aerosols, highly inflammable materials or containers with such materials.

6 Construct a safety barrier out of ropes and stakes or scaffold poles to ensure public is kept at a safe distance from the fire.

7 In daylight, and just before lighting, check that there are no children or animals playing or hiding in the bonfire. Arrange for, and brief sufficient numbers of marshals.

8 The person looking after the fire should not wear lightweight clothing that could ignite easily. They should wear a substantial outer garment of wool, or other material of

low flammability, and stout boots. They should know what to do in the event of a burn injury, or a person's clothing catching fire, and should have a fire blanket ready in the bonfire area along with a number of fire extinguishers.

9 Lighting: the safest and recommended approach is to use paper and solid firelighters in six places just inside the walls of the beacon to ensure an even burn. Never use flammable liquids such as paraffin or petrol to get it going as this can result in uncontrolled spread of fire or explosion.

10 To light the beacon: from poles 2m in length, prepare hand torches for lighting with paraffin-soaked rags wired around one end. Remember, paraffin is dangerous and great care should be taken. Paraffin can be used as directed, but it is still dangerous and should at all times be treated with great care - for example, always ensure all excess paraffin is drained off rags before use. If spilt on your clothes during the preparation of your beacon lighting you should replace those items of clothing before approaching any naked flames. In particular, always remember to replace the lid on any container of unused paraffin and store it in a safe place away from naked flames. Do not use an accelerant on the fire itself.



Bonfire Beacon, Shipston-on-Stour, Warwickshire, England.

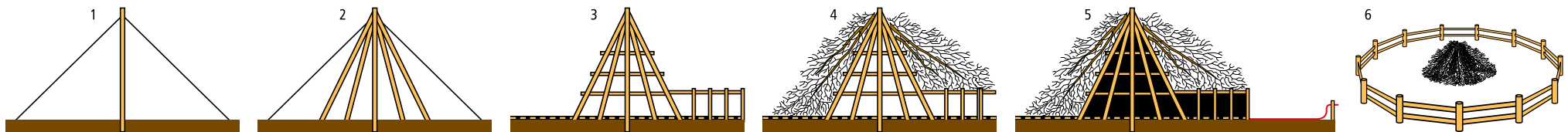

▲ After the event, extinguish fire and collect remaining debris. ▲ Dig over site and re-lay turf. ▲ Leave site clean and tidy.



Your Legal Essentials and Safety

If you are inviting personal guests to your home it is worth checking with your household insurer that you are covered in the unfortunate circumstances that there should be an accident. If your event includes inviting the public, or it is a third party venue then, where applicable, the following advice should be heeded, to ensure you have a safe and enjoyable event for everyone involved.

Licensing

Your local authority is responsible for licensing of such events. This includes the sale of alcohol (please see separate section) and Regulated entertainment, which includes live and recorded music along with other types of entertainment. Generally if there are going to be no more than 499 people present at your event, including staff and performers you can apply for as Temporary Event Notice. This is a simple process and can be obtained from your local Council and completed on line for only £21. If you expect more than the 499 people you will require a Premises licence to allow your event to take place. This process takes at least 28 days after you have submitted your forms, so leave plenty of time, the process may seem complicated but you can get assistance from your local licensing service at the Council. Local authorities will treat each event individually. The licensing officer's job is to advise the local authority's licensing committee on the granting of a licence should anyone object. If there are no objections the licence will be granted but you may have to agree to some conditions. It is always worth checking before you apply with the Councils licensing service to see if location already has a licence, as some open spaces are already licensed. Talk to the licensing officer as soon as possible. In Northern Ireland, if you plan to sell alcohol at an event, you will need to apply for an occasional liquor license from the Northern Ireland Court Service.

Safety Advisory Groups

A lot of local authorities run Safety Advisory Groups for events, these groups consist of all emergency services plus other members such as the Highways authority. They can provide you with all the information you require and some have example event plans to assist you organising your events, you can normally contact them through your local Council or the Police events officers.

Insurance

Unfortunately accidents can happen at even the best organised events. Therefore you will need to consider and obtain insurance cover for your event, whether you are holding an event on your own premises or someone else's. Beacon/Bonfire events require specialist public liability cover. If you hire a park or venue or use land owned by a third party for your activity, they are likely to require you to have your own suitable insurance to cover your liability for any injury to the public or damage to other people's land or property. If hiring equipment for the event, you may need to insure these items; you may also need to consider cover for loss of any financial outlay you incur if the event has to be cancelled for reasons beyond your control, or loss of money, particularly if you are holding a fund-raising event. To help you obtain the appropriate insurance, and risk management advice, we are working closely with Unity Insurance Services, which is a specialist insurance broker in the voluntary and non-profit sector. They have developed a range of bespoke insurance covers specifically for the Beacon/Bonfire events. Unity is owned by a charity, The Scout Association, and donates all its profits back to charity. To obtain a quote or for more details or advice on the insurance cover you may need, please visit Unity's website, www.unityinsuranceservices.co.uk/beacons or telephone them on 0345 040 7702.



Alternatively, the licensing officer may be able to direct you to a suitable specialist company or broker, but you should not try to source this kind of insurance from a non-specialist.



Emergency Services

Tell the police well in advance about the type of event you are planning, and get in touch with your local community police officer. Write to the fire brigade and ambulance service, particularly if you are planning to have a Beacon/Bonfire, fireworks, or an event that will attract a large crowd. St John's Ambulance and the British Red Cross will provide first aid and sometimes a vehicle. You can be expected to be charged for these services. If your Council has a Safety Advisory group this process will be part of the process and will save time.



Food and Drink

Basic food hygiene guidelines should be followed at all times if you are providing food and drink. Caterers must have food hygiene certificates. Advice on this subject can be obtained from your local council environmental officer. If you are using outside catering companies check with your local authority to see if they are a registered food business.



Alcohol

If you wish to sell alcohol at your event you will need to obtain a licence, please see the section above on licensing, it is important that you obtain the correct permissions and your local authority Licensing service will help you do this. You can normally use a temporary events notice for a bar as only a small number of people can be present (less than the 499 limit).



Site Clearance

The local authority will arrange for clearance and disposal of litter after your event if it is on public ground (check for possible charges). You can help this process by arranging litter bins or recycling bins around the site, and a crew to clear up throughout the event.



Hiring or Borrowing Equipment

Your local authorities, or local event organisers may be able to help you with contacts for supplies such as marquees, portable toilets, barriers and bunting, or may in some cases have these for you to hire and borrow. You may also need to consider generators, a public address system, and emergency flood lighting. If you need to arrange insurance for your hired equipment, Unity Insurance Services can arrange this for you too. If you hire a Marquee make sure the company providing it provide you with the necessary safety certificates.



All Ability Access

Access for the disabled is very important. Many local authorities run community transport schemes. Talk to them about arranging transport. On green field sites access may be improved by cutting the grass before the event.



The Royal Naval Association is proud to be associated with 'Battle's Over - A Nation's Tribute'

With over 16,000 members across 300+ branches in the UK and overseas, we are a family of current and former Naval Service personnel, relatives and supporters of our country's Royal Navy.

Whether we are catching up with friends at our regular social events; fundraising; advising on welfare and employment matters, or just providing an arm around the shoulder, our natural willingness to help others stems from the tradition and camaraderie that only Naval Service life can instil. Everything we do is inextricably linked to our core values:

Unity

Shared backgrounds and equality in rank. We share the same bonds, the same mindset, and even the same language (Jackspeak!). We are all equal. We are the heart and soul of the RNA.

Loyalty

To each other and our dependants. We will always support and look out for each other. Our loyalty is to all our shipmates, our local communities, the personnel and dependants of the Naval Service, along with other charities or organisations with naval connections.

Patriotism

We are proud to serve and proud to represent our country and the Naval Service. Our pride in serving our country never leaves us. Nor do we forget those who have fallen for our country or who fight now. We are deeply honoured to represent them on both a national and international level.

Comradeship

Friends in fun, fellowship and need. Your shipmates will always be here for you, whether it's about a job, ideas for a fun day out or just an arm around the shoulder. We will never leave you or your dependants in despair.

The Royal Naval Association has lots of great things going on:

- Project Semaphore to bring digitally isolated naval veterans online.
- Befriending naval veterans who need an arm around the shoulder.
- 3 minibuses fitted with wheelchair hoist for socially isolated veterans.
- Support for those leaving the Royal Navy - the Shipmates and Oppos programme.
- We support and lead the Conference of Naval Associations, a group of 70 like-minded naval associations, bringing great benefits and working together. www.cona.org.uk/
- Most importantly we have fun together with our regular meetings and organised events - such as our annual reunion and Conference and the Remembrance Sunday march at the Cenotaph.

The RNA has been involved with many aspects of commemoration of the First World War.

- Our National Standard led the parade at the National Event at Lyness cemetery on the Orkneys for the Battle of Jutland, our members have been part of many events.
- We have lent the Chapel door of HMS WARSPITE to the National Museum of the Royal Navy - for their Jutland Exhibition running in Portsmouth from 2016 to 2020.
- We are the lead sponsor with the Woodland Trust in the establishment of the Jutland Wood as part of their WW1 Centenary Wood Project. The wood will consist of 6,094 trees - reflecting the number of Royal Navy sailors who lost their lives on that day in May 1916. The RNA has sponsored two of the large specimen trees in the main avenue, and hope to have members at the planning at Langley Vale Epsom in the Winter of 2017.

www.royal-naval-association.co.uk

RNA Central Office, Room 209, Semaphore Tower,
HM Naval Base, Portsmouth, PO1 3LT

admin@royalnavalassoc.com
02392723747

You can donate to the RNA at:
www.royalnavalassociation.co.uk/about-us/help-us/



ROYAL NAVAL ASSOCIATION

ABF The Soldiers' Charity is the National Charity of the British Army. Originally established as the Army Benevolent Fund in 1944, we provide a lifetime of support to soldiers, veterans and their immediate families in times of need.

How we help

We give financial assistance to individuals as well as make grants to a large number of specialist charities and partner organisations such as Combat Stress, SSAFA and the NSPCC, which provide support on our collective behalf.

The scope of our work is huge; from providing funding for specialist medical equipment for the 6-month old child of a serving soldier, to assisting with the care home fees of a 105-year-old veteran, our work touches the lives of around 80,000 people each year, sustaining the British Army 'family' both at home and around the world. We are The Soldiers' Charity: 'For Soldiers - For Life'.



How you can help

From abseils, skydives and 24-hour hikes across the Scottish wilderness, to cake sales, big curries and cycling challenges, there are many ways for you to get involved and support our work. However you choose to support us, your contribution will go a long way to making a difference to the lives of serving and veteran Army personnel, and their families.

We don't receive any statutory government funding, so we rely on the generosity of our supporters to ensure we can continue to be here, supporting the men and women of the British Army.

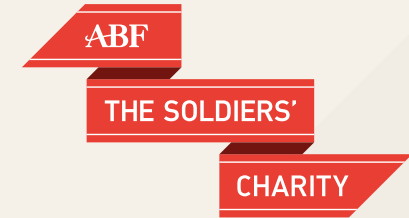

The Army's National Charity

For more information on The Soldiers' Charity or to make a donation, visit www.soldierscharity.org or email info@soldierscharity.org



facebook.com/soldierscharity



[@soldierscharity](https://twitter.com/soldierscharity)



instagram.com/soldierscharity

ABF The Soldiers' Charity is a registered charity in England and Wales (1146420) and Scotland (039189). Registered as a company limited by guarantee in England and Wales (07974609).

Registered Office: Mountbarrow House,
12 Elizabeth Street, London SW1W 9RB

THE HEART OF THE RAF FAMILY SINCE 1919



**Royal Air Force
Benevolent Fund**
THE HEART OF THE RAF FAMILY



Since our foundation in 1919, the RAF Benevolent Fund has been there, through thick and thin, supporting the RAF family.

Our principal activities are to provide assistance to the RAF family when they are in need, maintain and preserve the RAF Memorial in London on behalf of the nation, support the morale and wellbeing of the serving RAF and be responsible for the Bomber Command Memorial in central London.

HOW WE HELP

We routinely help over 41,000 individuals every year, by providing a range of support aimed at serving and former RAF personnel. We also support members of the Air Cadet Organisation, including members of the Combined Cadet Force RAF component, if they are injured whilst on duty.

They include welfare breaks for families and veterans, grants to help with getting about inside and outside the home, specialist advice on benefits and care services, individual grants for RAF Stations and Station personnel and support for young people through our Airplay programme.

By working with others, we ensure that members of the RAF family get the right support, when it's needed. Last year we gave over £1m in external grants to over 50 charities and organisations including RAFA, SSAFA and the Royal British Legion.

HOW YOU CAN HELP

There are lots of ways you can get involved with the RAF Benevolent Fund and we always welcome your support.

And don't forget whatever you do, no matter how small, will go a long way in helping us make a difference to the lives of RAF personnel, past and present, and their families. From cake sales to fun runs, cycling challenges to dinners, your support matters.

We receive no regular government funding, so we rely entirely on people like you to continue our work supporting the men, women and children of the RAF family whenever they are in need.

For more information on the RAF Benevolent Fund or to make a donation, visit www.rafbf.org, or email info@rafbf.org.uk.





The Merchant Navy Association

from ship to shore, from past to present

The merchantile marine, as it was termed in those times, played a significant and often critical role throughout the First World War...much the same as it would two decades later. In both world wars merchant seafarers and fishermen fought the enemy, the weather and the seas to keep the nation and the Armed Services supplied and able to defend themselves. Their way of life and conditions of service were austere with seafarers often not returning home for over two years, some having been sunk, survived and transferred to other ships to maintain those lines of support.

During the First World War attacks on merchant and fishing vessels began quite slowly but increased significantly as the enemy sought to blockade Great Britain. In 1914 and 1915 a total of 342 merchant vessels were lost to enemy action with 2,471 men, women and boys losing their lives. During 1916 there were 396 ships and 1,217 seamen killed. In the following year, 1917, the losses were so severe that the ships being built could not match the number of ships being lost in action with six ships a day being sunk on some days. The loss of life was increasing significantly. It was so severe that if the rate of losses of ships and men had continued the war would have been lost. No food, no fuel, no wood, no arms and ammunition especially some of the 91 million shells that were eventually produced and transferred by sea. In that year 1,197 ships were sunk through enemy action and 6,408 seamen were lost at sea with their ships...their only grave the sea. The losses had to be decreased and this was achieved by the introduction of the Convoy System in 1917. In 1918 the impact of the actions in the previous year were clearly evident with 544 ships and 4,122 seamen lost.

The total recorded losses for the First World War were 2,479 ships and 14,287 seamen plus 675 vessels of the fishing fleet and 434 seamen. There were many more seafarers who died ashore and were not commemorated. They had to die at sea to be commemorated even when they were hospitalised because of their wounds. They were also off pay when their ships were sunk. They actually had to die at sea to be commemorated.

The men, women and boys who were lost at sea during the First World War included lads such as Redan Sydney Jeffries (aged 13) of Lowestoft, presumed drowned on 24th October 1917. Redan was a Cook aboard the fishing vessel Vanguard. More than twenty-nine Boy seamen aged only 14 lost their lives for their King and Country. At the other end of the scale were men long overdue for retirement who insisted on "doing their bit" and who paid the ultimate sacrifice. Men such as A.B. Patrick Casey, aged 73, killed when the S.S. Dotterel was sunk by a mine off the French coast on 29th November 1915....they were the forgotten heroes, their lines of support were never broken.

Capt J M R Sail MNM MNI, MNA National Chairman

**Please donate what you can, when you can,
as often as you can. Small donations will make a
big difference.**

**Contact www.mna.org.uk
and access the DONATE button.**

Battle's Over - A Nation's Tribute & WWI Beacons of Light Acknowledgements

This event is being organised in association with:

The Army Cadet Force, Air Training Corps, Sea Cadet Corps, Combined Cadet Force, Association of English Cathedrals, Royal Naval Association, ABF The Soldiers' Charity, Royal Air Force Benevolent Fund, Merchant Navy Association, The Buglers Association of The Light Division & Rifles, Trinity House, National Association of Local Councils, National Association of Civic Officers, One Voice Wales, National Trust, English Heritage and the National Union of Mineworkers (formerly known as Miners Federation of Great Britain).

We would like to thank the many and various councils, churches, organisations, local communities, commercial companies, private land owners and others to date listed below, for their generous participation in this unique, local community tribute.

There are a number of others taking part as private occasions, so are not open to the general public so have asked not to be listed.

(The Merchant Navy Association will be lighting 12 further Beacons, the locations of which will be confirmed nearer the date).

ENGLAND

BEDFORDSHIRE

Leighton-Linslade Town Council
Silsoe Parish Council
Potton Town Council
Luton Borough Council
Billington Parish Council
Stanbridge Parish Council
Shefford Town Council
Millbrook Parish Meeting

BERKSHIRE

Wraysbury Parish Council
Newbury Town Council
Slough Borough Council
Datchet Parish Council
Englefield Estate
Royal Borough of Windsor and Maidenhead & Crown Estate
Hungerford Town Council
Sunningdale Parish Council
Donnington Castle – (English Heritage)

BUCKINGHAMSHIRE

The Parks Trust – Milton Keynes
Olney Town Council
Akeley Parish Council
Wolverton & Greenleys Town Council
Berryfields Parish Council
Stoke Poges Parish Council
Beaconsfield Town Council
Great Horwood Parish Council
Little Horwood Parish Council
Quainton Parish Council
Cublington Parish Council
Steeple Claydon Parish Council
Whaddon Parish Council

CAMBRIDGESHIRE

St Neots Town Council
Huntingdon Town Council
Chatteris Town Council
Eltisley Village
Warboys Parish Council
Cottenham Parish Council
Sawtry Parish Council

CHESHIRE

Northwich Town Council
St Oswald's Church – Lower Peover
Beeston Parish Council & Beeston Castle
Alsager Town Council
Tushingham, Macefen & Bradley Parish
Winsford Town Council
Frodsham Town Council & Frodsham WWI
Commemoration Working Group
Disley Parish Council
Little Budworth Parish Council
Wybunbury Parish Council
Beeston Castle- (English Heritage)

CLEVELAND

Billingham Town Council

CORNWALL

St Michael's Mount (Far West tip of England)
Torpoint Town Partnership
Lizard Lighthouse - Trinity House
Pelynt Parish Council
St Mabyn Parish Council
Liskeard Town Council
St Stephens by Launceston Rural Parish Council
Penzance Town Council

Helson Town Council & Helston WWI Heritage Project
South Petherwin Parish Council
Madron Parish Council
Gwennap Parish Council
Marazion Town Council
Carn Brea Parish Council
Probus Parish Council
St Enoder Parish Council
Morval Parish Council
The Ruan Social Group (RSG)
St Cleer Royal British Legion - & other organisations
Rotary Club of Bodmin

COUNTY DURHAM

Brandon and Meadowfield Royal British Legion
Shotley Bridge Cricket Club
Ferryhill Town Council
Hartlepool Borough Council
Waldridge Parish Council
St Andrew's Church - Winston
Brandon & Byshottles Parish Council
Manfield with Cliffe Parish Council
Great Aycliffe Town Council



Acknowledgements

Barnard Castle Town Council
Spennymoor Town Council
Coxhoe Parish Council
Barnard Castle – (English Heritage)
Eggleston Parish Council

CUMBRIA

Brampton Parish Council
Provincial Grand Lodge of Cumberland and
Westmorland Freemasons
Whitwell and Selside Parish Meeting
Mansergh Parish Meeting
Heversham Parish Council
Matson Ground Estate Co Ltd
Cumberland & Westmorland Freemasons
Windermere Lodge 2217
Windermere Town Council
Torver Parish Council
Coniston Parish Council
Dalston Parish Council
Milburn Parish Council
Muncaster Parish Council (3 Beacons)
West Cumberland Freemasons
Lamplugh and District Heritage Society &
Lamplugh Young Farmers
Maryport Town Council
Scaleby Parish Hall Committee
Bootle Parish Council, Millom Without Parish
Council and Whicham Parish Council
Bewcastle Parish Council
Dearham Parish Council
Millom Town Council
Blindbothel Parish Council
Carlisle Castle – (English Heritage)
Birdoswald Roman Fort – (English Heritage)

DERBYSHIRE

Erewash Borough Council (2 Beacons)
South Derbyshire District Council
Shardlow Church and Shardlow & Great Wilne
Parish Council

Duffield Parish Council
Pilsley Parish Council
Northwood and Tinkersley Parish Council
Bradwell Parish Council
Aston on Trent Parish Council
Horsley Woodhouse Parish Council & Horsley
Woodhouse Scout Group
Whaley Bridge Town Council
High Peak Borough Council
Chelmorton Parish Council
Derbyshire & Lancashire Gliding Club
Peveil Castle – (English Heritage)

DEVON

Blackborough Village
Bishopsteignton Parish Council
Delamore Estate
Lympstone Parish Council
Exeter City Council
Kings Nympton Community Group
Germansweek Parish
Start Point - Trinity House
Plympton & District Civic Society
Morchard Bishop Parish Council
Buckland Brewer Parish Council
Crediton Town Council
Hennock Parish Council
Borough of Poole
Newton Abbot Town Council (3 Beacons)
Lifton Parish Council
South Tawton Parish Council
Okehampton Hamlets Parish Council
Chagford Parish Council
Strete Parish Council
Peter Tavy Parish Council
Newton Poppleford and Harpford Parish
Council
Bideford Town Council
Clifford Estate Company Ltd & Chudleigh
Town Council
Luppitt Parish Council

DORSET

Portland Bill – Trinity House
Sturminster Newton Town Council
Bournemouth Council
Beaminster Town Council
Bere Regis Parish Council
Charmouth Parish Council

EAST & WEST SUSSEX

Crowborough Town Council
Community of Brightling Village
Wave Leisure Trust Ltd
Shining Lights (Bexhill Ltd)
Winchelsea Artefacts Society
Crawley Borough Council
1st Horam Scout Group & Horam Parish
Council
Alfriston Parish Council
Burwash Parish Council
Northiam Parish Council
Hamsey Parish Council & East Chiltington
Parish Council
Willingdon and Jevington Parish Council
Milland Parish Council
Uckfield Town Council
Hooe Parish Council
Bognor Regis Town Council
Heathfield and Waldron Parish Council
Newick Parish Council with Newick Bonfire
Society

EAST YORKSHIRE

Rowley Parish Council
Sutton upon Derwent Parish Council
Market Weighton Town Council
Kilpin Parish Council
Hessle Town Council
Sancton All Saints Church PCC
Withernsea Town Council
Hedon Town Council
Beverlet Town Council

ESSEX

Broxton Parish Council
White Colne Parish Council
Burnham-on-Crouch Town Council
Wivenhoe Town Council
Harwich Pier – Trinity House
St Lawrence Parish Council
Rochford District Council
Fryerning Parish Council
Waltham Abbey Town Council
Harwich Society
High Easter Parish Council
St Lawrence PCC
Maldon District Council
West Bergholt Parish Council
Loughton Town Council
Billericay Town Council
Great Bentley Parish Council
Great Canfield Parish Council
Colchester Borough Council
Great Totham Parish Council
Margaret Roding Parish Council
Little Easton Parish Council
Ilford East Scout District

GLOUCESTERSHIRE

Girlguiding Gloucestershire
Wotton Under Edge & District Round Table
Stow on the Wold Town Council
Lydney Town Council
Cheltenham Trust & Cheltenham Town Hall
Wickwar Parish Council
Oldbury on Severn Parish Council
Windrush Parish Meeting
Adlestrop Village



Acknowledgements

GREATER MANCHESTER

Stockport Metropolitan Borough Council
Tameside Council & Tameside Armed Services
Community
Manchester Cathedral
Bolton Metropolitan Borough Council

HAMPSHIRE

East Meon Parish Council
Odiham Parish Council
Liss Parish Council
Candovers Parish Council
Portsmouth City Council
Bramley Parish Council
Damerham Parish Council
Denmead Parish Council
Hythe Marina Centre
West End Parish Council
Bishop's Waltham Parish Council
Hythe and Dibden Parish Council
Overton Parish Council
Hurst Castle – (English Heritage)
Porchester Castle – (English Heritage) in
association with Fareham Borough Council

HEREFORDSHIRE

Hereford City Council
Ross-on-Wye Town Council

HERTFORDSHIRE

Benington Recreation Ground Charity Trust
Hormead Community Group
St Stephen Parish Council
Highfield Park Trust
Stevenage Borough Council
Hertfordshire County Council
Shenley Parish Council
Perry Green and Green Tye Preservation
Society
Welwyn Hatfield Borough Council
St Albans City and District Council

ISLE OF WIGHT

St Catherine's Lighthouse, Southern Tip of the
Isle of Wight – Trinity House
The Royal British Legion – Isle of Wight
County Committee
Carisbrooke Castle – (English Heritage)

KENT

East Peckham Parish Council
Temple Ewell Parish Council
Hildenborough Parish Council
Canterbury City Council
Westenhanger Castle & Stanford Parish
Council
8th Sheppey Scout Group
Dymchurch Parish Council
North Foreland – Trinity House
Petham Village
Yalding Parish Council
River Parish Council
Benenden Parish Council
Hawkhurst Parish Council
Chislet Parish Council
Rusthall Parish Council
Aldington and Bonnington Parish Council
Saint Peter and Saint Paul's Church –
Farningham
Snodland Town Council
St Nicholas-at-Wade & Sarre Parish Council
Lyminge Parish Council
Lydd Town Council
Hever Residents Association and Hever Parish
Council
Bidborough Parish Council
Broadstairs & St Peter's Town Council
10th Deal Eastry Scouts
Ashford Borough Council
Friends of Capel Church
Badlesmere Parish Hall
Great Chart Remembers – Great Chart
Eastry Parish Council

Tenderden Town Council
Birchington Parish Council
Borough Green Parish Council
Plaxtol Parish Council
New Romney Town Council
Hartlip Parish Council
Dover Town Council
Newchurch Parish Council
Woodnesborough Parish Council
Lamberhurst Parish Council
Chilham Parish Council
Egerton Parish Council
Sutton Valance Parish Council
Stockbury Parish Council
Hartley Parish Council
Detling Parish Council
Hoo St Werburgh Parish Council
Leeds Parish Council
Wye with Hinxhill Parish Council
Harrietsham Parish Council
Wickhambreaux Parish Council
Mersham and Sevington Parish Council
Westerham Town Council
Horton Kirby and South Darenth Parish
Council
Staplehurst Parish Council
Westwell Parish Council
Newington History Group – Newington
Dover Castle - (English Heritage)
Longfield and New Barn Parish Council
Appledore Local History Society

LANCASHIRE

Staining Parish Council
Earby Town Council
West Lancashire Borough Council
Whittington Parish Council
Wyre Council
Chorley Council
Fylde Borough Council
Lancaster City Council

Pilling Parish Council
Duchy of Lancaster - Lancaster Castle &
Lancaster City Council
Whitworth Town Council
West Bradford Parish Council
Grindleton Parish Council
Cronton Parish Council
Hambleton Parish Council
Bretherton Parish Council
Bold Parish Council
Ribby with Wrea Parish Council & Westby with
Plumpton Parish Council
Little Ecclestone and Larbreck Parish Council
Preesall Toen Council
Slaidburn & Easington Parish Council
Warton Parish Council
Whittle-le-Woods and Clayton-le-Woods War
Memorial Committee
Mellor Parish Council
Whittle-le-Woods Parish Council
Catforth Village Memorial Hall

LEICESTERSHIRE

Husbands Bosworth Parish Council
Leicestershire County Council
Fleckney Parish Council
Great Easton Parish Council
Broughton Astley Parish Council
Ashby de la Zouch Town Council
Thorpe Acre Scout Group

LINCOLNSHIRE

International Bomber Command Centre
Worlaby Parish Council
Hibaldstow Parish Council
Elsham Parish Council
Corby Glen Parish Council
Haxey Parish Council
Pinchbeck Parish Council & St. Mary's Church
Deeping St James Parish Council



Acknowledgements

Stapleford Parish Meeting
Metheringham, Sots Hole and Tenvats Parish
Council
Epworth Town Council
Scopwick and Kirkby Green Parish Council
Scrivelsby Estate
North East Lincolnshire (3 Beacons)
Louth Town Council
Barrowby Parish Council

LONDON

Merchant Navy Association National Memorial
– Tower Hill, London
Royal Borough of Greenwich (3 Beacons)
Barnet Borough Scouts
London Borough of Havering
Ealing Council
London Borough of Islington
London Borough of Camden

MERSEYSIDE

Billinge Chapel End Parish Council

NORFOLK

Thorpe St Andrew Town Council
Potters Leisure Resort
Melton Constable Parish Council
Cromer – Trinity House
The Greyhound Inn – Hickling
Shouldham Parish Council
Ashill Parish Council
Norfolk Tank Museum
Lingwood and Burlingham Parish Council
Wells Harbour Commissioners
Honing Village Hall
Thetford Town Council
Claxton Parish Council
Letheringsett with Glandford Parish Council
Wiveton Parish Council
Downham Market Town Council
Ashwellthorpe and Fundenhall Parish Council

Overstrand Parish Council
Necton Parish Council
Marshland St James Parish Council
Walpole Cross Keys Parish Council
Barton Bendish Parish Council
Swanton Novers Parish Council
Langham Parish Council
Norwich City Council
Great Yarmouth Borough Council
Rollesby Parish Council
Blakeney Parish Council
Surlingham Parish Council
Dersingham Parish Council
Attleborough Town Council
Garvestone, Reymerston & Thuxton Parish
Council
Hockham Parish Council
Wood Norton Parish Council
Regis Parish Council
Rollesby Parish Council
Chedgrave Parish Council
Hoveton Parish Council
Hardingham Parish Council and Village Hall
Committee
Acle Bridge Inn, Acle
Great Massingham Parish Council
Tittleshall Parish Council
Norfolk District Council
Heacham Parish Council

NORTHAMPTONSHIRE

Thrapston Town Council
Corby Borough Council
Little Addington Parish Council
Raunds Town Council
Fartheringhoe Parish Council
Brackley Town Council
Irthlingborough Town Council
Northamptonshire County Council & All Saints'
Church
Crick Parish Council

Grendon Parish Council
Harlestone Parish Council
Duston Parish Council
Cogenhoe and Whiston Parish Council
Litchborough Parish Council
Cold Higham Parish Council
Whittlebury Parish Council
Helmdon Parish Council
Bozeat Parish Council

NORTHUMBERLAND

Heugh Hill (Holy Island) – Trinity House
Morpeth Town Council
Amble Town Council
Ford & Etal Estates with the North
Northumberland Branch of The Royal British
Legion
Lindisfarne Priory (English Heritage)
Housesteads Roman Fort – (English Heritage)
Berwick-upon-Tweed Barracks – (English
Heritage)

NORTH YORKSHIRE

Richmond Town Council
West Tanfield Committee
Danby Beacon Trust
Bentham Town Council
Masham Parish Council
Spofforth with Stockeld Parish Council
Skipton Town Council
Bewerley Parish Council
Tadcaster Town Council
Tan Hill Inn (HIGHEST PUB IN GREAT
BRITAIN)
Barlby and Osgogby Town Council
Leavening Parish Council
Settle Town Council
Goldsborough Hall
Willerby Parish Council
Riccall Parish Council
Dalton on Tees Parish Council

Gateford Parish Council
Langthorpe Parish Council
Wistow Parish Council
Askham Richard Parish Council
Rudby Parish Council
Burton in Lonsdale Parish Council
Whitley Parish Council
Escrick Parish Council
Sherburn Parish Council
Clapham cum Newby Parish Council
Eskdaleside cum Ugglebarnby Parish Council
Knaresborough Town Clerk
Scagglethorpe Parish Council
Baldersby & Baldersby St James Parish
Council
Great Ayton Parish Council
Darley & Menwith Parish Council
Settringham Parish Council
Long Preston Parish Council
Rawcliffe Parish Council
Middleham Town Council
Thirsk Royal British Legion in association with
the Rotary Club of Thirsk
Scarborough Castle – (English Heritage)
Richmond Castle – (English Heritage)
Whitby Abbey – (English Heritage)
Pickering Castle – (English Heritage)
Middleham Castle – (English Heritage)
Roecliffe & Westwick Parish Council

NOTTINGHAMSHIRE

Nottingham City Council
Kimberley Town Council
Clarborough and Welham Parish Council
Flintham Parish Council
Costock Parish Council
Bunny Parish Council
Wysall Parish Council
Willoughby on the Wolds Parish Council
Elston Parish Council
Normanton on the Wolds Parish Council



Acknowledgements

Shelford Parish Council – Nottinghamshire
Plumtree Parish Council
East Stoke Parish Council
Whatton in the Vale Parish Council
Thurgarton Parish Council
Stanton on the Wolds Parish Council
East Markham Parish Council

OXFORDSHIRE

Wootton Memorial Playing Field Committee
Abingdon-on-Thames Town Council
Swinbrook & Widford Parish Council
Upper Lea Farm
Vale of White Horse & Faringdon Town Council
Brightwell Baldwin Parish Meeting
Lockinge Estate with Ardington & Lockinge Parish Council
The Bix Branch of The Royal British Legion
Greatworth Parish Council
Swyncombe Parish Council

RUTLAND

Rutland County Council

SHROPSHIRE

Clive Parish Council
Burwarton Estates
Sibdon Parish Meeting
Whixall Parish Council
Cound Parish Council
Ightfield and Calverhall Parish Council
Much Wenlock Town Council
Bayston Hill Parish Council & Bayston Hill Scouts

SOMERSET

North Somerset Council
Sedgemoor District Council
AH Trollope-Bellew
Long Ashton Community Association
Peasedown St John Parish Council

Kingsdon Parish Council
Everard Family – Broford Farm
Trull Parish Council
Midsomer Norton Town Council
Cucklington Parish Meeting
Williton Parish Council
Priddy Parish Council & Priddy Friendly Society
Chard Town Council
Clatworthy Parish Council
Priston Parish Council
St Cuthbert (Out) Parish Council
Ilminster Town Council

SOUTH YORKSHIRE

Tickhill Town Council
Hunshelf Parish Council
Charles & Rosalind Buckler
Tankersley Parish Council
Rotary Club of Sheffield Vuclan
Hellaby Parish Council
Austerfield Parish Council
Penistone Agricultural Show
Wales Parish Council
Burghwallis Parish Council
Sykehouse Parish Council
Brinsworth Parish Council
Wadworth Village Hall Committee
Conisbrough Castle – (English Heritage)

STAFFORDSHIRE

Lichfield City Council
Cheddleton & Wetley Rocks Parish Council
Parish of Quinton & Admington
Endon with Stanley Parish Council
Cannock Chase Council
Stone Town Council
Rugeley Town Council
Loggerheads Parish Council

SUFFOLK

West Row Village War Memorial, West Row
Bures St Mary Parish Council & Bures Royal British Legion
Dukes Head – Somerleyton
Levington and Stratton Hall Parish Council
Orford & Gedgrave Parish Council
Mendlesham Parish Council
Sudbury Town Council
Nacton Community Council
Waveney District Council
Little Thurlow and Great Thurlow Parish Councils
Friston Parochial Church Council
Ipswich Borough Council
Metfield Parish Council
Alderton Parish Council
Burstall Parish Council
Sroughton Parish Council
Holton St Mary Village
Barnham Parish Council
Beccles Town Council
Kedington Parish Council and Kedington & District Branch Royal British Legion
Haverhill Town Council
Aldeburgh Town Council
Glemham Hall Events
Woodbridge Town Council
Laxfield Parish Council
Cockfield Parish Council (Suffolk)
Woolverstone Village with Woolverstone Parish Council & Ipswich High School for Girls
Great Bealings Parish Council
Bungay Town Trust
Woolpit Parish Council
Boxford Community Council
Kirton & Falkenham Parish Council
Beck Row, Holywell Row & Kenny Hill Parish Council
Whepstead Community Association
Benhall & Sternfield Parish Council
Clare Community Association (CCA)

Brent Eleigh Parish Council
Badingham Parish Council
Capel St Mary War Memorial Trust
Hepworth Parish Council
Rushmere St Andrew Parish Council
Norton Parish Council
Kettlebaston Parish Council
Hitcham Parish Council
Wissett Parish Council with Wissett Community Council & Church Councils
Great Ashfield Parish Council

SURREY

Farnham Castle
Caterham Festival Committee
West End Parish Council
Normandy Parish Council
Guildford Borough Council & Guildford Lions Clubs
Reigate and Banstead Borough Council
Worplesdon Parish Council
Royal British Legion (Pirbright Branch)
Lingfield Parish Council
Dormansland Parish Council

TYNE AND WEAR

Tynemouth Priory

WARWICKSHIRE

Royal Leamington Spa Town Council
Stratford-upon-Avon Town Council
Snitterfield Parish Council
Fillongley Parish Council
Harbury Parish Council
Priors Hardwick Village
Bishop's Itchington Parish Council
Salford Priors Parish Council
Brinklow Parish Council
Coleshill Town Council
Ansty Parish Council
Budbrooke Parish Council



Acknowledgements

WEST MIDLANDS

St Stephen's Church – Rednal
Birmingham City Council
Solihull Metropolitan Borough Council
St Peter's Church – Wolverhampton
Wythall Community Association

WEST SUSSEX

Southbourne Sea Scouts
Burgess Hill Town Council
Littlehampton Town Council
Twineham Parish Council

WEST YORKSHIRE

Wakefield Metropolitan District Council
Strathmore/Blackshaw Parish
Hebden Royd Town Council
Clifford Parish Council
Hemsworth Town Council
Emley Millennium Green
Normanton Town Council
Collingham with Linton Parish Council
Kippax British Legion & Kippax Parish Council
R&CP Haigh and Sons
Barwick in Elmet Parish Council
Scholes Parish Council
Woolley Village Residents Association

WILTSHIRE

Manorial Court for the Hundred & Borough of Cricklade
Steeple Ashton Bellringers
Semington Village
Sutton Benger Village Hall & Recreation Ground Charity
Westbury Town Council
Stanton Saint Bernard Parish Council
Amesbury Town Council
Stratton St Margaret Parish Council
Stonehenge – (English Heritage)

WORCESTERSHIRE

Worcestershire County Council
Severn End Estate
Ripple Parish Council & Great Mongeham Parish Council
Hindlip, Martin Hussingtree & Salwarpe Parish Council
Romsley Parish Council
Kempsey Parish Council
Overbury Enterprises
Rock Parish Council

CHANNEL ISLANDS & ISLE OF MAN

SARK

STATES OF ALDERNEY

STATES OF GUERNSEY

STATES OF JERSEY

ISLE OF MAN

Isle of Man Government
Isle of Man Civil Defence

NORTHERN IRELAND

St Macartin's Cathedral (MOST WESTERLY CATHEDRAL IN THE UNITED KINGDOM)
Antrim and Newtownabbey Borough Council (2 Beacons)
Ards and North Down Borough Council (3 Beacons)
Armagh City, Banbridge and Craigavon Borough Council

SCOTLAND

Aberdeen City Council
Argyll Estates
West Lothian Council
North Ayrshire Council
The Royal Burgh of Annan Community

Council & Annan Branch of the Royal British Legion
Renfrewshire Lieutenancy
Unst Community Council (MOST NORTHERLY INHABITED ISLAND IN THE UK)
The National Trust for Scotland
Colpy/Culsalmond (Williamston Estates)
Clackmannanshire Council
Mridrum and Bourtie Community Council
Old Rayne Community Association

WALES

St David's City Council (THE MOST WESTERLY CITY IN WALES)
Amroth Village / Amroth Arms
Mumbles Community Council
St Anne's Head – Trinity House
Newport City Council
St Mary Hill Church
Carmarthen Town Council
Llangynidr Beacon Committee
Wrexham County Borough Council
Cowbridge with Llanblethian Town Council
Beaumaris Town Council
Welshpool Town Council (2 Beacons)
Magor with Undy Community Council
Fishguard and Goodwick Town Council
Menai Bridge Town Council
Penhow Community Council
Martletwy Community Council
Llandefalle Hall Committee
Penally Community Council
Pembrey and Burry Port Town Council
Usk Town Council
Portskewett Community Council
Whitton Community Council
Caernarfon Royal Town Council
Narberth Town Council
Llansteffan and Llanybri Community Council
Saundersfoot Community Council

Montgomery Town Council
Rhayader Town Council
Langstone Community Council
Llanwenog Community Council
Rhuddlan Town Council
Bridgend Town Council
Cyngor Cymuned Dolbenmaen (Dolbenmaen Community Council)
Llantwit Major Town Council
Shirenewton Community Council (Monmouthshire)
Dyffryn Cennen Community Council
The Havens Community Council
Cyngor Tref Criccieth Town Council
Abergwyngregyn Regeneration Company (ARC) – Parish of Abergwyngregyn
Llanfair Clydogau Village Hall Committee
Llanfihangel Rhydithon Community Council
Mawr Community Council
Abergavenny Town Council
Abetillery and Llanhilleth Community Council
Aberporth Community Council
Haverfordwest Town Council
Cyngor Tref Tywyn/Tywyn Town Council

UNITED KINGDOM OVERSEAS TERRITORIES

Government of South Georgia & South Sandwich Islands
St Helena – South Atlantic Ocean Ascension Islands Government
Falkland Islands Council
Tristan da Cunha
Government of the Virgin Islands
Government of Bermuda
Pitcairn Island



Battle's Over - A Nation's Tribute & WWI Beacons of Light

Chosen Charities

Please give generously to one or more of our four chosen charities for this unique, historic tribute to the many that either died or returned home dreadfully wounded defending our freedom during the four dark years of World War I.



**ROYAL NAVAL
ASSOCIATION**

Please donate at:
www.royal-naval-association.co.uk/about-us/help-us/



**Royal Air Force
Benevolent Fund**
THE HEART OF THE RAF FAMILY

Please donate at:
www.rafbf.org/ways-to-give

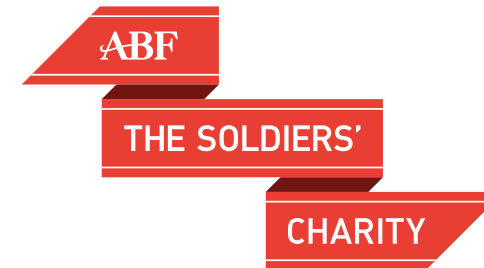

The Army's National Charity

Please donate at:
www.soldierscharity.org



The Merchant Navy Association

Please donate at:
www.merchantnavyfund.org



TMS Media - Pagemasters to the Pageantmaster



24-page brochure for Trafalgar Weekend 21-23 October 2005.



8-page menu for Trafalgar Night Dinner 21 October 2005.



8-page guide to taking part in The Great Poppy Party Weekend 10, 11, 12 June 2011.



8-page guide to taking part for The Queen's Diamond Jubilee Beacons 4 June 2012.

Few design agencies have the privilege of working on projects of national significance.

From celebrations to mark the 200th anniversary of the Battle of Trafalgar and the 90th anniversary of the Royal British Legion to Fly a Flag for the Commonwealth, TMS Media has had the pleasure of working with Pageantmaster Bruno Peek on events that celebrate many important milestones in our history and culture.

Much of Bruno's work has associations with historic anniversaries, for example, The Queen's Diamond Jubilee Beacons project was a high-profile televised celebration for which we designed a guide to taking part and a website for people and organisations to register events around the country.

Our creative work for the hugely successful Fly a Flag for the Commonwealth in 2013 also included a website and a guide, which has been updated to showcase some of the many exciting events that took place in its inaugural year.

We're delighted to be the Pagemasters to the Pageantmaster.

01493 662929 www.tms-media.co.uk



8-page guide to taking part for 70th Anniversary of VE Day 8 May 2015



8-page guide to taking part for Fly the Red Ensign for Merchant Navy Day 3 September 2015



A unique 124-page leather-bound book listing all the Beacon locations for The Queen's Diamond Jubilee Beacons was presented to The Queen 4 June 2012.



36-page guide to taking part for Fly a Flag for the Commonwealth 14 March 2016



20-page guide to taking part for The Queen's 90th Birthday Beacons 21 April 2016



BATTLE'S O V E R

A NATION'S TRIBUTE

11TH NOVEMBER 2018

100 YEARS OF REMEMBRANCE

WW1 Beacons of Light 11th November 2018

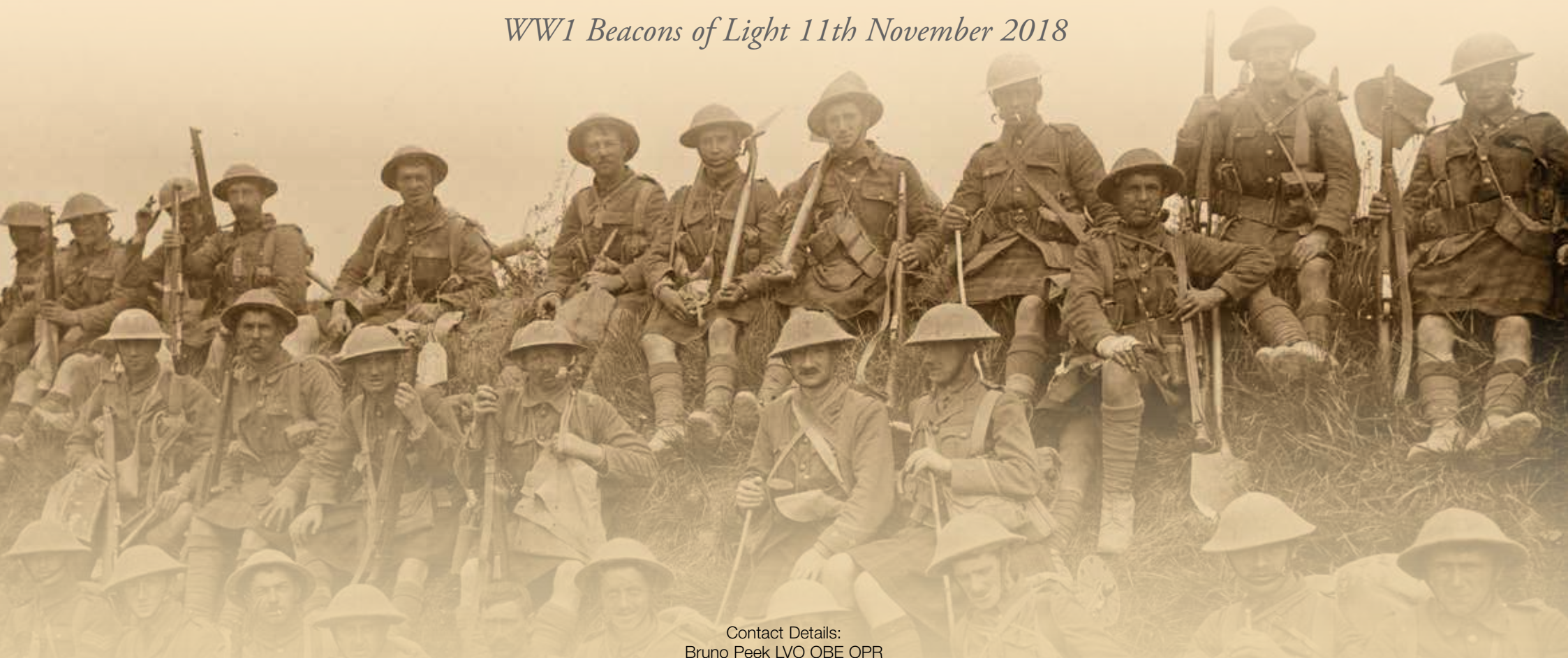

Contact Details:

Bruno Peek LVO OBE OPR

Pageantmaster

Battle's Over - A Nation's Tribute & WW1 Beacons of Light 11th November 2018

Mobile: + 44 (0) 7737 262 913 (8am - 8pm) Monday - Saturday

Email: brunopeek@mac.com

